

# Trilogy Series

## DL3000 Programming Instructions

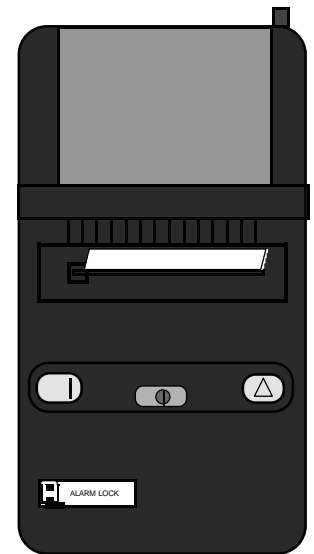
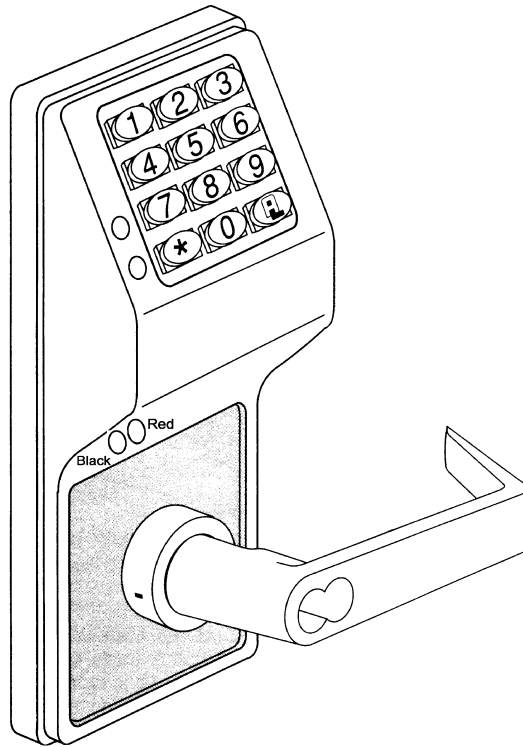

### DL3000 Trilogy Series Standalone Access Control System

# Table of Contents

<b>Features</b> .....	4
Audit Trail .....	4
User Features .....	4
150 Scheduled Events .....	4
Keypad and Download Programming .....	4
AL-IR1 Infrared Printer .....	4
AL-DTM Data Transfer Module .....	4
<b>Additional Features</b> .....	5
Ambush Function .....	5
User Associated for more than one Group .....	5
Service Code .....	5
Keypad Lockout .....	5
Non-Volatile Memory .....	5
Error Checking .....	5
Real Time clock .....	5
Programmable Relay Functions .....	5
Programmable Timeout Functions .....	5
<b>Advanced Features</b> .....	5
Manager Initiated Functions .....	5
<b>Wiring and Power Up</b> .....	6
Terminals .....	6
Power Up - Retain Lock Information .....	6
Power Up - Erase all Programming .....	6
AL-DTM Data Transfer Module .....	6
Self Diagnostic Indications .....	6
<b>Preliminary Information</b> .....	7
Lock Operation .....	7
Programming Notes .....	7
LED Indications .....	7
Audible Indications .....	7
<b>Getting Started</b> .....	8
Battery Installation .....	8
Entering Program Mode .....	8
Setting the Clock .....	8
User Programming .....	9
Printing User code Lists .....	9
Printing the Audit Trail .....	9
<b>Methods of Programming</b> .....	10

# Table of Contents

<b>Programming Functions</b> .....	11
New Master Code.....	11
Add/Delete/Change User Codes .....	11
Disable User.....	11
Enable User .....	11
User Enable with Timeout.....	12
User Lockout Mode.....	12
Change User Program Level Ability .....	12
Enable User 300 (Service Code) .....	12
Erase All Users Except the Master Code .....	12
Clear All Schedules and Timeout Functions.....	13
Clear All Timeout Functions .....	13
Enable/Disable Groups .....	13
Group Disable/Enable with Timeout .....	14
Add/Delete Group Association.....	14
Set Date.....	15
Set Time.....	15
Set Day of Week.....	15
Daylight Savings Time Enable/Disable .....	15
Clock Adjust .....	16
Passage Mode Enable/Disable.....	16
Timed Passage Mode.....	16
Passage Mode Enable/Disable - Schedule will not Override .....	17
Pass Time.....	17
Printer Functions.....	18
Downloading.....	18
AL-DTM Door Number .....	19
Lockout .....	19
Remote Input.....	19
Ambush .....	19
Relay .....	20
Enter Key .....	20
Scheduled Passage Mode Enable/Disable .....	20
Scheduled Group Enable/Disable .....	21
Quick Schedules .....	22
Scheduled Passage Mode - Group 1 Activated .....	22
Scheduled Relay Activation - Group 1 Activated.....	23
Scheduled Group 4 Enable - Group 1 Activated.....	23
Clear Programming and History LOG .....	23
<b>Using Advanced Features</b> .....	24
<b>Programming Record Sheet</b> .....	25
<b>User Code Record Sheet</b> .....	26
<b>Schedules</b> .....	27
<b>Warranty</b> .....	28

# Features

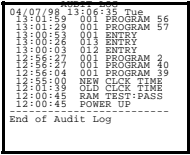

## Audit Trail - 1600 Events

- Time/Date Stamped Log of all Entries
- Logs program mode changes
- View Audit Trail:
  - Print using the AL-IR1 hand-held printer
  - Upload using Alarm Lock's DL-WINDOWS Software
  - Use Alarm Locks AL-DTM to upload multiple lock logs.



## User Features

- 300 User Codes
- Master, Manager, Supervisor and Basic User Codes
- 3, 4, 5 or 6 digit User Codes
- Service Code (One-Time-Only Code)
- User Lockout Mode - Total user lockout except User 1 code
- 4 User Groups



## 150 Scheduled Events

- Programmed to Unlock/Lock
- Disable/Enable Users
- 4 "Quick Schedules" - allows programming of the 4 most common time schedules in one step

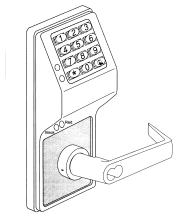

## Keypad and Download Programming

All programming may be done from the keypad, or from a PC, using Alarm Lock's DL-Windows Software.

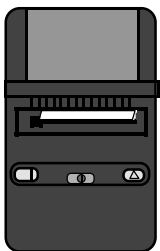

## AL-IR1 Infrared Printer

Optional hand-held infrared printer may be used to print the Audit Trail and User Code List.



## AL-DTM Data Transfer Module

Optional Data Transfer Module. Use Alarm Lock's AL-DTM to easily transfer program data between up to 48 locks and a PC running DL-WINDOWS software. Easily transfer Audit Trail from multiple locks and then view or print each Audit Trail from a computer.

# Additional Features

## Ambush Function Relay Terminals

1. Connect terminals 5 & 6 to a device able to properly monitor normally open dry contacts for an ambush condition.
2. Program the Relay for *Ambush Function Activated* (10) using Program Function 67.
3. Set the Ambush Code using Program Function 66.
4. When the ambush code is entered followed by a valid user code, the relay will close for 2 seconds.

## Ambush Code

The ambush code defaults to **99**. An error will sound if you try to program a new user code starting with the ambush code.

## Users Associated for more than one group

If a user is associated with more than one group, all associated groups would have to be disabled before the user is disabled.

## Service Code

User number 300 is the service code. Once the service code is used, it is disabled. Function 9 is used to re-enable the service code.

## Keypad Lockout

Programmable number of attempts before keypad lockout.  
Programmable lockout time.

## Non-Volatile Memory

All programming is stored in non-volatile memory.

## Error Checking

Extensive keypad program error checking reduces likelihood of programming error.

## Real Time Clock

Real time clock allows logging of events to within one second accuracy. Unique feature (Functions 43/44) allows speeding up or slowing down the clock providing long term accuracy of the clock functions to within 3 minutes per year.

## Programmable Relay Functions

Relay may be programmed to energize when one or more selected events occur.

## Programmable Timeout Functions

Timeout functions allow enabling/disabling users and enabling passage mode for a time period without requiring

# Advanced Features

## Group 1 Activated Features

### Group 1 Member in puts lock in Passage

#### Mode Feature (88 & 89)

1. Use Function 88 to set an *Open Time Window*. The lock will unlock (Passage Mode) when any Group 1 Member enters a code.

2. Use Function 89 to set the time to close the window.

**Note:** Passage Mode will have to be disabled each night using Function 46 or schedule Function 73.

**Example:** Open window at 7:00AM using function 88, Close Window at 8:30AM using function 89.

Lock will unlock when a member of group 1 enters their code between 7:00AM and 8:30AM. If no group 1 member arrives between 7:00AM and 8:30AM, the lock will stay locked all day.

### Disarming a Burglary Control Panel (90 & 91)

1. Connect terminals 5 & 6 to a burglar control panel with switch input for disarming.
2. Use Function 90 to set the time to open the window

allowing any Group 1 Member to close the relay for 2 seconds. **Note:** Only 1 relay closure will occur even if another member of group 1 enters their code.

3. Use Function 91 to set the time to close the window.

**Note:** The alarm panel will have to be armed at night by the user or by an automatic schedule function of the alarm panel.

**Example:** Open window at 7:00AM using program Function 90, Close Window at 8:30AM using Function 91.

The relay will close, one time only, when a member of group 1 enters their code between 7:00AM and 8:30AM.

### Group 1 Member Enables Group 4 Users (92 & 93)

1. Use Function 92 to set the time to open the window allowing any group 1 member to enable group 4.

2. Use Function 93 to set the time to close the window.

**Note:** Group 4 will have to be disabled each night using Function 17 or schedule Function 82. **Example:** Open window at 7:00AM using Function 92, close window at 8:30AM using Function 93. Group 4 will be enabled when a member of group 1 enters their code between 7:00AM

# Wiring and Power Up

## Terminals (Standard Models Only)

**1 & 2 (Operation without Batteries)** - Optional 7.5 VDC Voltage for operation without batteries.

**3 & 4 (Remote Input)** - Wire a Normally Open Contact to Terminals 3 & 4. Momentarily close to allow person to pass through door. **NOTE:** Remote Input is enabled from the factory.

**5 & 6 (Normally Open Relay)** - See Function 67 for programming options for the Relay.

**PC Interface** - Connect to Serial Port on Computer using A-PCI interface cable.

## Battery Replacement

When a valid code is entered and the batteries are weak the lock LED will light amber, and the sounder will sound for 4 seconds. The DL3000 uses 5 AA-size 1.5 volt alkaline batteries. The lock will function with weak batteries; however be sure to replace the batteries as soon as possible.

## Wire Leads for DL3000WP Models

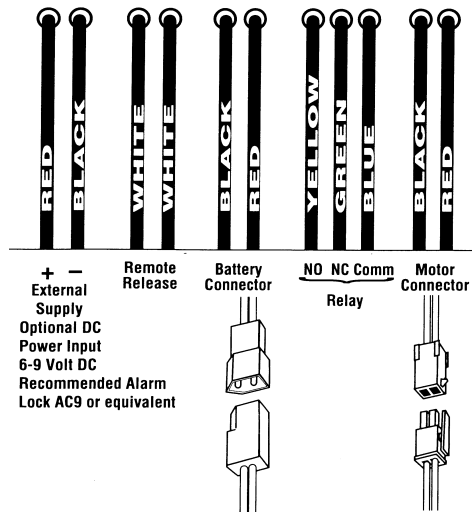

Remove the screw at the bottom of the housing and remove the cover. Replace all 5 batteries quickly - within 2 minutes.

**Note:** Do not press any buttons while replacing the batteries (unless lock programming is to be erased). Pressing any key will remove the voltage that is required to keep the system clock and Audit Trail.

## Power-Up - Retain Lock Programming

(Audit Trail and Clock Settings lost)

1. Remove at least one battery.
2. Press any key to insure the locks capacitor is fully

## Power-Up - Erase All Programming

(Factory Default will be loaded)

1. Remove at least one battery.
2. Press any key to insure locks capacitor is fully discharged.
3. Re-install battery (lock will give 3 short beeps).
4. **Press any key within 5 sec after hearing the 3 beeps.**
5. A series of 12 slow beeps will be heard followed by 20 seconds of silence, followed by 6 fast beeps.

All programming has been erased and the lock is now ready for use.

**Note:** All lock programming can also be erased by entering Function 99.

## Self Diagnostic Indications

Various system tests are performed at power up and during operation of the lock.

**Steady 4 Second Sounder with a Yellow LED indication every time a user code is entered** - indicates a Low Battery Condition.

**Continuous Series of Beeps** - indicates the lock detected a system fault which would not allow any part of the system to operate. Ensure batteries are good.

**Sequence of 7 Beeps Repeated 4 Times with a Yellow LED indication, every time a user code is entered** - indicates a non-fatal memory or clock error has been detected. Under this condition, unexpected operation is possible. Do not mistake the low battery indication as a memory or clock error.

# Preliminary Information

## Lock Operation

**Important:** Before attempting to program any codes or functions, Note the following:

- While the lever or knob may be rotated at any time, the latch will not be engaged to unlock the door unless a valid code has been entered.
- When a valid code is entered, the lock will unlock immediately and remain unlocked for about 5 seconds (or longer, if reprogrammed by functions 52 and 53).

LED Indications	
<b>Key Press</b> - The red LED will light momentarily whenever a key is pressed.	<b>RED LED</b>
<b>Wrong Code</b> - If a wrong code is entered, the red LED will flash 6 times.	
<b>Valid Code</b> - The green LED will come on momentarily when a valid code has been entered.	<b>GREEN LED</b>
<b>Low Battery</b> - Will light when keys are pressed to indicate a low battery condition.	<b>YELLOW LED</b>
<b>Program Mode Entered</b> - Indicates that the program mode is entered.	

Audible Indications	
<b>Key Press</b>	A beep will sound with each key press
<b>Invalid Code</b>	6 beeps
<b>Low Battery Indication</b> (Sounds when a valid code is entered)	A 4-second tone
<b>Successful Program Entry</b>	2 short beeps
<b>Unsuccessful Program Entry</b>	7 short beeps

## Programming - Notes

### NOTE:

Following a Power Up, Function 1 (New Master Code) must be accessed before any other programming function is permitted.

It is recommended that all programming be prepared in advance using the **DL3000 Programming Sheets** for reference while programming (see User Code and Schedule Recording sheets at the back of this manual), then be secured when finished.

### PROGRAM LEVELS

You must have the programming authority level **equal** to the authority level required to access a programming function. Programming authority levels can have a value of 1, 2, 3, 4 or M. A programming authority level of M (Master) is associated with the Master Code and cannot be associated with any other user. **Note:** Having a Program Authority Level of 3 does not allow access to programming Functions with required authority levels of 1, 2 or 4.

### MASTER, MANAGER, SUPERVISOR AND BASIC CODES

Program ability and Group association for most users can be modified through programming. To keep structure to the user codes, the following suggested hierarchy of codes is defaulted when adding codes using Program Function 2.

**Master Code - User 1:** Always enabled and can program all functions, can't be group associated

**Manager Codes - Users 2 - 6** (Program Set Ability of 1, 2, & 3): Can program all functions except functions relating to lock configuration, no default group association.

**Supervisor - User 7 - 11** (Program Level Ability of 1 & 2): Can only program functions relating to day to day operation, no default group association.

# Programming Information

Function Name

Programming Information

**Enabling/Disabling Users (By User Number)**

• User Number must be between 2 and 300.  
NOTE: Will Enable/Disable users even if the user is associated with a enabled group.

2

3. Disable User    3    [ \_ \_ ]   

4. Enable User    4    [ \_ \_ ]

**Program Level Required** - The program level required to access the Function. Possible Programming Levels of 1,2,3,4 and M, where M = Master Code. Program Authority Level of User must be **equal** to the Function that

Programming key

### General Program Mode Information

If a wrong key is pressed during code entry, press the button repeatedly until the error sound is heard (7 short beeps), this will clear the entry, then re-enter the key sequence again.

# Getting Started

## Battery Installation

Remove the back cover and install batteries as shown. The lock will beep 3 times. To load the default program press any key within 5 seconds, the lock will beep slowly while the default values are loaded and beep rapidly upon completion.

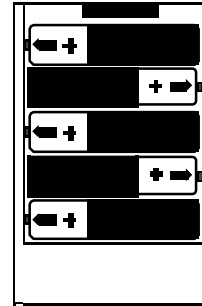

## Entering Program Mode

1. Enter Master Code        
Default Master Code
2. Enter

### Program Mode

The keypad sounder will beep every 6 seconds and the keypad LED will flash green every 6 seconds while in program mode when no keys are pressed. **NOTE:** There is a 3 minute Timeout if no keys are pressed while in Program Mode.

## Program a new Master Code.

New Master Code      Confirm New Master Code

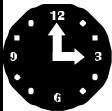

**Setting the Clock** - While still in **Program Mode** enter the following commands to set the clock.

### Program the Date.

Date

For Example: March. 8, 1998;  
Enter:

### Program the Time.

Time

For Example: To set time to 8:25 P.M.;

Enter:

For Example: To set time to 8:25 A.M.;

Enter:

### Program the Day of the Week.

Day

For day enter: 1 for Sunday, 2 for Monday, 3 for Tuesday, 4 for Wednesday, 5 for Thursday, 6 for Friday and 7 for Saturday.



# Getting Started



## User Programming

### Add a Basic User Code

Program a User Code of 987. Use Function 2, and add the new user as User 12 (Users 12-50 are Basic Users). Refer to Function 2 (page 11).

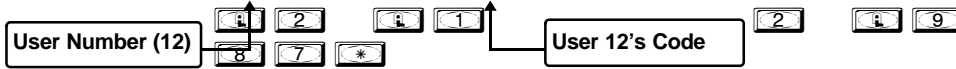

### Add another Basic User Code

Program a User Code of 246. Use Function 2, and add the new user as User 13. Refer to Function 2 (page 11).

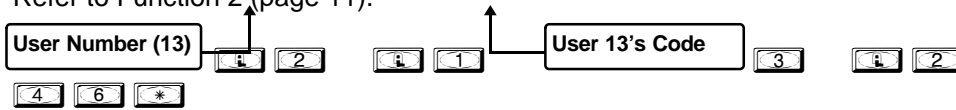

### User code conflicts

Care should be taken not to program a new user code which matches the first digits of any other user code. (only the code with the least number of digits would be recognized). **Example:** If user codes 123 and 123456 are both entered in the system only code 123 would be recognized.

To program user codes that match the first digits of other codes, see program Function 69.

An error will sound if you try to program a new user code which matches the first digits of the Master User Code (User Number

## Exit Program Mode

### Optional

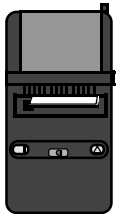

**Print the Lock's Time, Date and Day programming to ensure the clock is set correctly.** Refer to Printer Functions (page 18) for proper Printer-Lock positioning.

From Program Mode enter the following command:



```
ALARM LOCK SYSTEMS, INC
VERSION DL26 org REC
04/07/98 13:11:28 Tue
Clock adjust setting +0
Cycle count hex 00000E
F39 day ct hex 00
```

**Print the Lock's User Code List.** Refer to Printer Functions (page 18) for proper Printer-Lock positioning.

From Program Mode enter the following command:



```
04/07/98 13:06:35 Tue
USER
ENABLED ?

USER | USER | GROUP | PROG
NUM | CODE |      | SETS
  1 | 123456 | E     | 1234
  12 | 987    | E     | .....
  13 | 246    | E     | .....
```

**Print the Lock's Audit Trail.** Refer to Printer Functions (page 18) for proper Printer-Lock positioning.

From Program Mode enter the following command:



```
----- AUDIT LOG -----
04/07/98 13:06:35 Tue
13:01:59 001 PROGRAM 56
13:01:29 001 PROGRAM 57
13:00:53 001 ENTRY
13:00:26 013 ENTRY
13:00:03 012 ENTRY
12:56:27 001 PROGRAM 2
12:56:27 001 PROGRAM 40
12:56:04 001 PROGRAM 39
12:55:00 NEW CLCK TIME
12:01:39 OLD CLCK TIME
12:01:30 001 PROGRAM 38
12:01:30 DATE CHANGED
12:01:07 001 ENTRY
12:00:48 CLK TEST:PASS
12:00:45 RAM TEST:PASS
12:00:45 POWER UP
-----
End of Audit Log
```

# Methods of Programming

## Keypad Programming

### Entering Program Mode

1. Enter Master Code   
 Default Master Code

2. Enter → "BeepBeep" "BeepBeep" "BeepBeep" "BeepBeep"  
 Sounder will sound 2 short beeps 4 times to indicate the program mode is active.

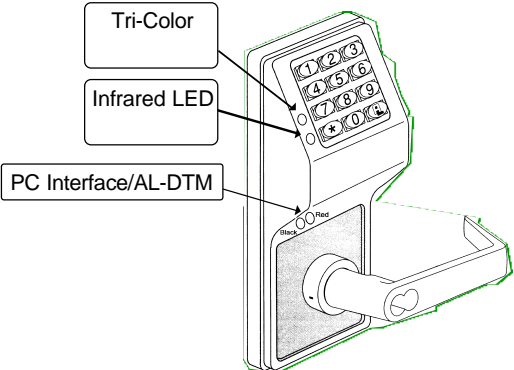

**Program the Master Code before programming any other Functions (New Lock or following a power up).**

### New Master Code (User Number 1)

[ \_ \_ \_ \_ ] [ \_ \_ \_ \_ ]   
 New Master Code Confirm Master Code

**Program Mode**  
 The keypad sounder will beep every 6 seconds and the keypad LED will flash green every 6 seconds while in program mode when no keys are pressed. **NOTE:** There is a 3 minute Program Mode Timeout if no keys are pressed while in Program Mode. A steady tone will sound indicating there is 15 seconds left to press a key or Program Mode will timeout.

### Exiting Program Mode

There are 2 ways to exit Program Mode:

1. Hold down any key for 3 seconds
2. Press no keys for 3 minutes (Program Mode Timeout).

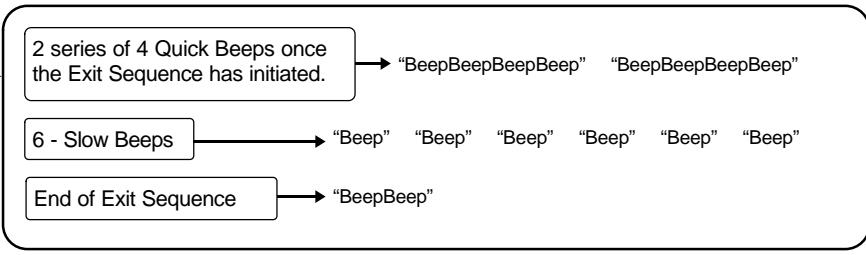

## Downloading

The DL3000 lock can also be programmed using a computer and Alarm Lock's DL-WINDOWS Software.

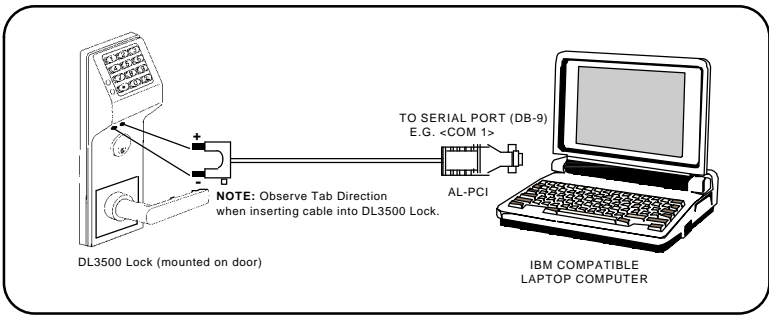

## AL-DTM

The DL3000 lock can also be programmed using Alarm Lock's AL-DTM Data Transfer Module and a computer running Alarm Lock's DL-WINDOWS Software.

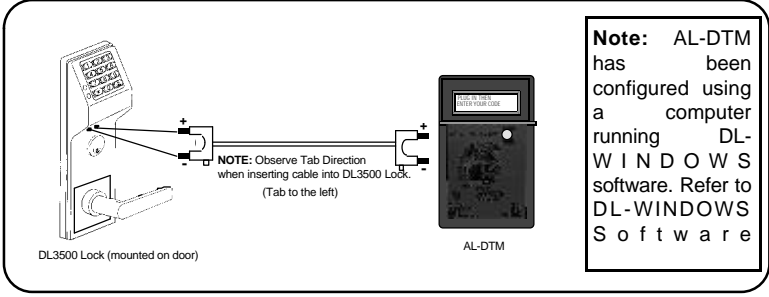

**Note:** AL-DTM has been configured using a computer running DL-WINDOWS software. Refer to DL-WINDOWS Software

# Programming Functions

## USERS

### 1. New Master Code (User Number 1)

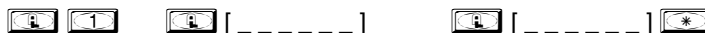

- Master Code must be 6 digits-only.

M

**NOTE:** Following a power up, Function 1 (New Master Code), must be accessed before any other programming function is permitted.

### 2. Add/Delete/Change User Codes 2-300



- User Number must be between 2 and 300.
- To delete a code, leave the User Code blank
- User Code must be 3-6 digits

3

Users programmed with Function 2 will default to a Group Association and a Program Level Ability as follows:

USER TYPE	USER NUMBER	DEFAULT GROUP ASSOCIATION	PROGRAM LEVEL ABILITY
Master Code	1	none	1, 2, 3, 4, Master
Manager Codes	2 - 6	none	1, 2, 3
Supervisor	7 - 11	none	1, 2
Basic User Codes	12 - 50	none	none
Basic User Codes Group 1	51 - 100	1	none
Basic User Codes Group 2	101 - 150	2	none
Basic User Codes Group 3	151 - 200	3	none
Basic User Codes Group 4	201 - 250	4	none
Basic User Codes	251 - 298	none	none
Non-Pass Code	299	none	none
Service Code	300	none	none

#### NOTE:

User 299 is a Non-Pass Code. This is the only code that will initiate data transfer with the AL-DTM. This code can be assigned program ability to allow printing the log to the handheld printer without allowing the user to pass through the door. This code may be used to record a guard's location in a building while "making his rounds".

### Enabling/Disabling Users (By User Number)

- User Number must be between 2 and 300

2

**NOTE:** Will Enable/Disable users even if the user is associated with an enabled group.

### 3. Disable User



### 4. Enable User



# Programming Functions

## USERS

### 5. User Enable with Timeout

(Enter Timeout, XXX Hours)

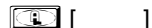

(User Number)



(XXX Hours)

- User Numbers must be between 2-300.
- Hours must be between 1 - 999

2

### User Lockout Mode

Enables/Disables all User Codes (Except User 1 Code) from operating the lock. **Note:** No other programming functions or schedules will re-enable users. Users must be re-enabled with function 7.

M

### 6. Enable Total User Lockout

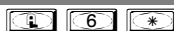

### 7. Disable Total User Lockout



### 8. Change User Program Level Ability



(User Number)



(Program Levels)

- User Number must be between 2 and 300.
- The ability to program one or more program levels may be selected.

3

**Example 1:** Allow User 67 to program levels 1, 2 and 4;

Enter:



**NOTE:** User 67 does not have access to Programming Functions with a Program Level Ability of 3.

**Example 2:** Prevent User 67 from programming any programming levels;

Enter:



**NOTE:** Having a Program Level Ability of 4 does not allow access to functions requiring a Program Level Ability of 3, 2 or 1. If multiple levels are required, program for each level that is required.

### 9. Enable User 300 (Service Code)

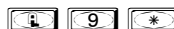

Service Code is a One-Time-Only Code. Once it is used, it is disabled until enabled again.

2

### 10. Erase All Users Except the Master Code

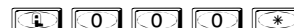
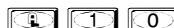

Erases all user codes except the Master Code (User 1).

M

### 11. Reserved

# Programming Functions

## CLEAR FUNCTIONS

### 12. Clear All Schedules and Timeout

Clears all programmed *Schedules* and all *Timeout Functions*. Includes Schedule Functions 72 to 93. Includes Timeout Functions 5, 25 to 34 and Function 47. **NOTE:** Up to 4 Timeout Functions may be pending at any one time. An error beep will sound if more than 4 Timeout Functions are attempted to be programmed.

3

### 13. Clear All Timeout Functions

Clears all programmed *Timeout Functions*. Includes functions 5, 25 to 34 and Function 47. **NOTE:** Only 4 Timeout Functions are allowed at any one time. An error beep will sound if more than 4 Timeout Functions are attempted to be programmed.

3

## GROUPS

### Enable/Disable Groups

Enter the functions below to Enable/Disable Groups.

2

14. Disable Group 1

15. Disable Group 2

16. Disable Group 3

17. Disable Group 4

18. Disable All Groups

19. Enable Group 1

20. Enable Group 2

21. Enable Group 3

22. Enable Group 4

23. Enable All Groups

24. Reserved

# Programming Functions

## GROUPS

**NOTE:** Clear All Timeout Functions by entering Function 13.

### Group Disable/Enable with Timeout (Enter Timeout, XXX Hours)

- Hours must be between 1 - 999
- Enter the functions below to Enable/Disable groups for the amount of time entered in hours. **NOTE:** Only 4 Timeout Functions are allowed at any one time. An error beep will sound if more than 4 Timeout Functions are attempted to be programmed.

2

- |                              |           |             |
|------------------------------|-----------|-------------|
| 25. Timed Disable Group 1    | [ _ _ _ ] | (XXX Hours) |
| 26. Timed Disable Group 2    | [ _ _ _ ] | (XXX Hours) |
| 27. Timed Disable Group 3    | [ _ _ _ ] | (XXX Hours) |
| 28. Timed Disable Group 4    | [ _ _ _ ] | (XXX Hours) |
| 29. Timed Disable All Groups | [ _ _ _ ] | (XXX Hours) |
| 30. Timed Enable Group 1     | [ _ _ _ ] | (XXX Hours) |
| 31. Timed Enable Group 2     | [ _ _ _ ] | (XXX Hours) |
| 32. Timed Enable Group 3     | [ _ _ _ ] | (XXX Hours) |
| 33. Timed Enable Group 4     | [ _ _ _ ] | (XXX Hours) |
| 34. Timed Enable All Groups  | [ _ _ _ ] | (XXX Hours) |

### 35. Add/Delete Group Association

[ \_ \_ \_ ] [ \_ \_ \_ \_ ]

(User Number) (Groups)

- Groups not Selected are Disassociated from the User
- User Number must be between 2 and 300.
- 1 or more (1-4) groups to associate with user may be selected.

**Add Example:** To associate user 67 with groups 1, 2 and 4;

Enter:

**Delete Example:** To remove all group associations for user 67;

Enter:

3

### 36 - 37. Reserved

# Programming Functions

## CLOCK SETTINGS

### 38. Set Date

[ \_ \_ \_ \_ ]

(Date)

- Use month day year format - MMDDYY - single digit months and days are entered with a preceding zero.
- Enter Only the last two digits of the year.

3

**For Example:** March. 8, 1998;  
Enter:

### 39. Set Time

[ \_ \_ \_ ]

(Time)

- Time must be 4 digits.
- Use 24 Hour Format (add 12 hours to program P.M. times)

3

**For Example:** To set time to 8:25 P.M.;

Enter:

**For Example:** To set time to 8:25 A.M.;

Enter:

### 40. Set Day of Week

[ \_ ]

(Day)

- For day enter: 1 for Sunday, 2 for Monday, 3 for Tuesday, 4 for Wednesday, 5 for Thursday, 6 for Friday and 7 for Saturday.

3

**For Example:** To set day to Sunday;

Enter:

### Daylight Savings Time Enable/Disable

**NOTE:** Daylight Savings Time Adjustment is 1st Sunday in April (time forwarded) until last Sunday in October (time regressed). Daylight Savings Time is enabled from the factory.

4

### 41. Enable Daylight Savings

### 42. Disable Daylight Savings

# Programming Functions

## CLOCK ADJUST

### Clock Adjust

- Number of seconds to Speed Up/Slow Down clock each day must be 0-55 seconds. Always consider the current setting when using this function. (Use of this function is not cumulative.) For example, if the clock needs to be sped up 10 seconds per day and the current setting is 10, program 20 seconds using Function 43.

4

**Example 1:** Clock is losing 13 seconds every day, enter:



This example assumes that the clock adjust setting was at the factory default of zero. Function 57 can be used to print the current clock adjust setting.

**Example 2:** Clock is gaining 13 seconds every day, enter:



This example assumes that the clock adjust setting was at the factory default of zero. Function 57 can be used to print the current clock adjust setting.

**Example 3:** To set the clock adjust setting back to the factory default of zero, enter:

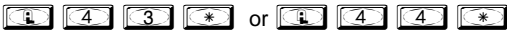

#### 43. Speed Up Clock





(seconds)

#### 44. Slow Down Clock





(seconds)

## PASSAGE MODE

### Passage Mode Enable/Disable - Schedule will Override

- Allows passage through the door without the need for a code using Function 45. Re-Lock using Function 46.
- Programmed Schedules will override the state of the lock using functions 45 and 46. If it is required that programmed schedules do not override passage mode, Enable/Disable

2

#### 45. Enable Passage Mode



#### 46. Disable Passage Mode



#### 47. Timed Passage Mode

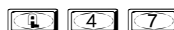



(XXX Hours)

- Hours must be between 1 - 999. Allows passage through the door without the need for a code for the programmed amount of time.

2



# Programming Functions

## PASSAGE MODE

### Passage Mode Enable/Disable - Schedule will not Override

- Allows passage through the door without the need for a code using Function 48. Re-Lock using Function 49.
- Programmed Schedules will not override the state of the lock using functions 48 and 49. If it is required that programmed schedules do override passage mode, Enable/Disable Passage mode using Functions 45/46. Use Function 50 to return the lock to scheduled functions.

2

#### 48. Enable Passage Mode



#### 49. Disable Passage Mode



#### 50. Return Lock to Normal Passage Mode Schedule

(The DL3000 will lock or unlock depending on the current schedule)



**NOTE:** See Scheduled functions 72 and 73 for scheduled passage mode.

## PASS TIME

### Pass Time

Use the functions below to change the pass time to 5, 10 or 15 seconds. The Pass Time is defaulted to 5 seconds. The Pass Time is the time the lock stays unlocked after a User Code is entered.

4

#### 51. Set Pass Time to 5 Sec.



#### 52. Set Pass Time to 10 Sec.



#### 53. Set Pass Time to 15 Sec.



#### 54. Reserved

# Programming Functions

## PRINTER

Hold the printer's tab perpendicular to the Lock's infrared LED as shown in Figure 1 and Figure 2. If the printer

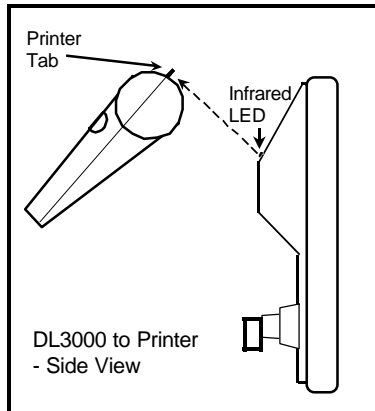

Figure 1

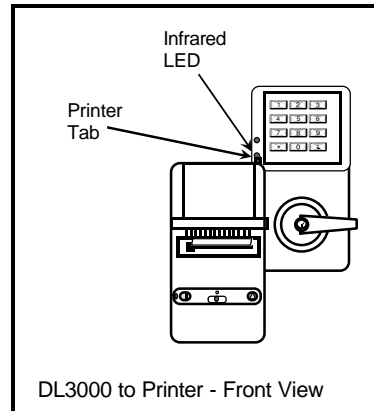

Figure 2

### 55. Print Audit Trail



Hold the printer over the lock's infrared sensor as shown in Figure 1 and Figure 2. 20 events will print at a time; press 1 for more events, or 9 to quit. To abort printing, press any key for 3 Sec (Three short beeps will sound).

1

### 56. Print User Code List



Hold the printer over the lock's infrared sensor as shown in Figure 1 and Figure 2. To abort printing, press any key for 3 Sec (Three short beeps will sound).

3

### 57. Print Clock Settings and Software Version



Hold the printer over the lock's infrared sensor as shown in Figure 1 and Figure 2.

1

## DOWNLOADING

### 58. Upload/Download PC Data



For use with DL-WINDOWS software, refer to OI237. AL-PCI interface cable needed.

3

# Programming Functions

## AL-DTM

### 59. AL-DTM Door Number

[ \_ \_ ]

(Door Number)

- Door Number must be between 1- 48. 4

For use with Alarm Lock's AL-DTM Data Transfer Module. Using the AL-DTM up to 48 locks can be Downloaded/Uploaded and History LOGs can be retrieved. Enter a door number for each lock. After configuring the AL-DTM, using Alarm Lock's DL-WINDOWS Software, any of the following data transfers can be initiated by plugging the AL-DTM into the lock and simply entering User Code 299 at the lock.

- Upload Lock Program
- Upload History LOG
- Download Lock Program

## LOCKOUT

### 60. Number of Attempt Before Lockout

[ \_ ]

(Number of Attempts)

- Number of attempts before lockout must be 1-9 attempts. 4
- The number of attempts is reduced by half every time the keypad is locked out without a successful code entry (default is 6 attempts).
- The attempt count is reset each time a valid code is entered.

### 61. Set the Attempts Lockout Time

[ \_ \_ ]

(Lockout Time)

- Lockout Time must be 1-60 seconds. 4  
How long the keypad is locked out after a series of unsuccessful attempts (default is 15

### 62-63. Reserved

## REMOTE INPUT

### Remote Input Disable/Enable

- Wire a Normally Open Contact to Terminals 3 & 4. Momentarily close to allow person to pass through door. 2
- Enter the functions below to Disable/Enable the Remote Input.

**NOTE:** The Remote Input is enabled as part of the default program.

### 64. Disable Remote Input

### 65. Enable Remote Input

## AMBUSH

### 66. Ambush Code

[ \_ \_ ]

(Ambush Code)

- Ambush code must be 2 digits. 3
- An error will sound if the ambush code matches the 1st two digits of any user code. See Using Ambush Function on page 5.

# Programming Functions

## RELAY

### 67. Add Relay Function

[ ] (Relay Function)

- Relay function must be 1-11 4
- Program 1 or more functions below to activate the Relay for 2 seconds when the following event occur:
- |                                |                          |                   |
|--------------------------------|--------------------------|-------------------|
| 1. Remote Input while enabled  | 6. Function 90 Activated | 11. Any key press |
| 2. Remote Input while disabled | 7. Locked by Schedule    |                   |
| 3. Failed Entry attempt        | 8. Unlocked by Schedule  |                   |
| 4. Disabled user entered code  | 9. Keypad Lock Out       |                   |

### 68. Delete All Relay Functions

Delete all Relay Functions programmed by Function 67. 4

## ENTER KEY

### Enter Key Enable/Disable (Allows Programming of Codes that Match the 1st digits of other Codes)

- When this function is enabled the user must press the key after a user code entry, this allows user codes which are subsets of other user codes. 4
- Example:
- is a valid user code;
- is a valid user code

69. Enable as Enter Key

70. Disable as Enter Key

### 71. Reserved

## SCHEDULES

### Scheduled Passage Mode Enable/Disable

Use the functions below to Enable/Disable Schedule Passage Mode. 3  
 For day enter: 1 for Sunday, 2 for Monday, 3 for Tuesday, 4 for Wednesday, 5 for Thursday, 6 for Friday and 7 for Saturday, 8 for Monday to Friday, 9 for Saturday and Sunday, 0 for all days of week.

72. Schedule Enable Passage Mode (Unlock) [ ] [ ]   
 (Day) (Time)

73. Schedule Disable Passage Mode (Lock) [ ] [ ]   
 (Day) (Time)

# Programming Functions

## SCHEDULES





**NOTE:** Clear All Schedule and Timeout Functions by entering Function 12.



### Scheduled Group Enable/Disable

Use the functions below to Enable/Disable Groups at the time programmed. 3

- For day enter: 1 for Sunday, 2 for Monday, 3 for Tuesday, 4 for Wednesday, 5 for Thursday, 6 for Friday and 7 for Saturday, 8 for Monday to Friday, 9 for Saturday and Sunday, 0 for all days of week.



#### 74. Schedule Enable Group 1

    [ \_ ]  
(Day)





 [ \_ \_ \_ \_ ]   
(Time)



#### 75. Schedule Enable Group 2

    [ \_ ]  
(Day)

 [ \_ \_ \_ \_ ]   
(Time)



#### 76. Schedule Enable Group 3

    [ \_ ]  
(Day)





 [ \_ \_ \_ \_ ]   
(Time)



#### 77. Schedule Enable Group 4

    [ \_ ]  
(Day)





 [ \_ \_ \_ \_ ]   
(Time)



#### 78. Schedule Enable All Groups

    [ \_ ]  
(Day)





 [ \_ \_ \_ \_ ]   
(Time)



#### 79. Schedule Disable Group 1

    [ \_ ]  
(Day)





 [ \_ \_ \_ \_ ]   
(Time)



#### 80. Schedule Disable Group 2

    [ \_ ]  
(Day)





 [ \_ \_ \_ \_ ]   
(Time)



#### 81. Schedule Disable Group 3

    [ \_ ]  
(Day)





 [ \_ \_ \_ \_ ]   
(Time)



#### 82. Schedule Disable Group 4

    [ \_ ]  
(Day)

 [ \_ \_ \_ \_ ]   
(Time)

#### 83. Schedule Disable All Groups

    [ \_ ]  
(Day)

 [ \_ \_ \_ \_ ]   
(Time)

# Programming Functions

## QUICK SCHEDULES

### Quick Schedules - Enable Group

- Group number must be 1-4  
Enter the number of the group that is to be enabled for the time specified for the Quick Schedules below:

3

**84. Business Quick Schedule**  
7AM-5PM, Monday - Friday

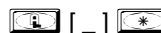

(Group)

**85. Day Quick Schedule**  
7AM-5PM, All days

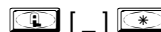
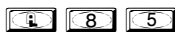

(Group)

**86. Evening Quick Schedule**  
3PM-1AM, All days

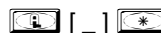

**87. Night Quick Schedule**  
11PM-9AM, All days

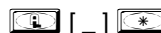

(Group)

## SCHEDULES GROUP 1 ACTIVATED

### Scheduled Passage Mode (Group 1 Activated)

- For day enter: 1 for Sunday, 2 for Monday, 3 for Tuesday, 4 for Wednesday, 5 for Thursday, 6 for Friday and 7 for Saturday, 8 for Monday to Friday, 9 for Saturday and Sunday, 0 for all days of week.
  - Enter time of day in 24 hour format.
- Enter the Open and Close Window Functions below to set up a Window where if any **Group 1 User Code** is entered within the programmed window, Passage Mode will be activated. See Group 1 Member in Puts Lock in Passage Mode on page 5.

3

**88. Passage Mode**  
(Open Time Window)

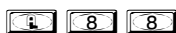

**89. Passage Mode**  
(Close Time Window)

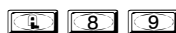

(Day)



(Time)

# Programming Functions

## SCHEDULES GROUP 1 ACTIVATED

### Scheduled Relay Activation (Group 1 Activated)

- Also program Relay Function 6 using Function 67 ( ) **3**
  - For day enter: 1 for Sunday, 2 for Monday, 3 for Tuesday, 4 for Wednesday, 5 for Thursday, 6 for Friday and 7 for Saturday, 8 for Monday to Friday, 9 for Saturday and Sunday, 0 for all days of week.
  - Enter time of day in 24 hour format.
- Enter the Open and Close Window Functions below to set up a Window where if any **Group 1 User Code** is entered within the programmed window the relay will be activated for 2 seconds. For use with a Control Panel that has a key switch disarm option (see *Disarming a Burglary Control Panel*). See Disarming a Burglar Alarm on page 5.

**90. Relay Activation**  
(Open Time Window)

[ \_ ] [ \_ \_ \_ \_ ]

**91. Relay Activation**  
(Close Time Window)

[ \_ ] [ \_ \_ \_ \_ ]

### Scheduled Group 4 Enable (Group 1 Activated)

- For day enter: 1 for Sunday, 2 for Monday, 3 for Tuesday, 4 for Wednesday, 5 for Thursday, 6 for Friday and 7 for Saturday, 8 for Monday to Friday, 9 for Saturday and Sunday, 0 for all days of week.
  - Enter time of day in 24 hour format.
- Enter the Open and Close Window Functions below to set up a Window where if any **Group 1 User Code** is entered within the programmed window Group 4 will be enabled. See Group 1 Member enables Group 4 Members on page 5.

**92. Enable Group 4**  
(Open Time Window)

[ \_ ] [ \_ \_ \_ \_ ]   
(Day) (Time)

**93. Enable Group 4**  
(Close Time Window)

[ \_ ] [ \_ \_ \_ \_ ]

**94 - 98. Reserved**

## CLEAR ALL PROGRAMMING AND HISTORY LOG

**99. Clear All Lock Programming and**

Clears all programming and History LOG.

**M**

# Using Advanced Features



## Advanced User Programming

### Add a User that is a member of Group 2 & Group 3

Program a User Code of 789 that is a member of Group 2. Refer to Function 2 (page 11). Use Function 2, and add the new user as User 101 (Users 101-150 are members of Group 2):

Add User 101:

Make User 101 also member of Group 3 using Function 35:

**Note:** Although User 101 is by default a member of Group 2, Group 2 must be included when using Function 35 or the Group 2 association will be removed.

## Note:

The example to add Users to Group 2 and Group 3 has been selected due to the fact that **Group 1 Activated Functions** require that a member a Group 1 enter their code to activate the function. Do not add general users to Group 1 if Manager Initiated Functions are to be programmed - Functions 88/89, 90/91 and 92/93.



## Group 1 Activated Features

### Add a User to Group 1

Program a User Code of 456789 that is also a member of Group 1. Use Function 2, and add the new user as User 2 (Manager).

Add User 2:

Make User 2 a member of Group 1 by using Function 35:

**Add Schedule that Opens the Lock (Passage Mode) when a member of Group 1 enters their code.**

Program a schedule using Function 88 and Function 89 between the hours of 6 A.M. and 10 A.M. for all days of the week.

Enter the Open Window Time of 6 A.M.:

Enter the Close Window Time of 10 A.M.:

The Lock will now be put in passage mode IF User 2 (or any Group 1 User) enters their code between 6 A.M. and 10 A.M.



If the lock is programmed as above. The lock will be put in passage mode IF User 2 enters their code between the hours of 6 A.M. and 10 A.M.

The Lock will have to be manually locked each night by entering the following command using Function 46:

**Manually close the Lock by entering the following command:**

The Lock can also be programmed to automatically close each night at 6 P.M. by adding a scheduled Lock Time using Function 73:

**Automatically (Scheduled Lock) close the Lock by entering the following command:**

## To Change to a different Group 1 Activated Function.

Replace functions 88 & 89 (Passage Mode Enable) with functions 90/91 (Burglar Alarm Disarm) or 92/93 (Group 4 Enable).

## Note:



Other Group 1 Initiated (Manager) Functions include:

**Disarming a Burglar Alarm** (Relay Activation) See functions 90/91.  
**Group 4 Enable** - See functions 92/93.



# Programming Record Sheet

Default Values are shown in parentheses.

Function Number(s)	Function Name	Programming		
40/41	Daylight Savings Time Enable/Disable	Enable • Disable • (Enable)		
43/44	Clock Adjust	+/- <table border="1" style="display: inline-table; vertical-align: middle;"><tr><td style="width: 20px; height: 20px;"></td><td style="width: 20px; height: 20px;"></td></tr></table> 0-55 seconds (0) (0) Seconds		
51/52/53	Pass Time	5 sec • 10 sec • 15 sec • (5 sec)		
59	AL-DTM Door Number	<table border="1" style="display: inline-table; vertical-align: middle;"><tr><td style="width: 20px; height: 20px;"></td><td style="width: 20px; height: 20px;"></td></tr></table> 1-48 (0) (1) Door Number		
60	Number of Attempt Before Lockout	<table border="1" style="display: inline-table; vertical-align: middle;"><tr><td style="width: 20px; height: 20px;"></td></tr></table> 1-9 attempts (6) Attempts		
61	Set the Attempts Lockout Time	<table border="1" style="display: inline-table; vertical-align: middle;"><tr><td style="width: 20px; height: 20px;"></td><td style="width: 20px; height: 20px;"></td></tr></table> 1-60 seconds (1) (5) Seconds		
64/65	Remote Input Disable/Enable	Enable • Disable • (Enable)		
66	Ambush Code	<table border="1" style="display: inline-table; vertical-align: middle;"><tr><td style="width: 20px; height: 20px;"></td><td style="width: 20px; height: 20px;"></td></tr></table> 01-99 (9) (9) Ambush Code		
67	Add Relay Function	Check all that apply <ul style="list-style-type: none"> <li>1. Remote Input while enabled •</li> <li>2. Remote Input while disabled •</li> <li>3. Failed Entry attempt •</li> <li>4. Disabled user entered code •</li> <li>5. Authorized Entry •</li> <li>6. Function 90 Activated •</li> <li>7. Locked by Schedule •</li> <li>8. Unlocked by Schedule •</li> <li>9. Keypad Lock Out •</li> <li>10. Ambush Function Activated •</li> <li>11. Any Key Press •</li> </ul>		
69/70	Enter Key Enable/Disable	Enable • Disable • (Disable)		

# User Code Record Sheet

User Number (1-300)	User Code (3-6 digits)						Group Association				Program Set Ability				User Name
							1	2	3	4	1	2	3	4	

**Note:**  
 For a complete list of user codes obtain a print out from either the remote printer (Program Function 56) or using the DL-3000 WINDOWS Downloading Software.

# Schedule Record Sheet

Function Number	Day(s)	Time	Function Name
	Up to 150 scheduled functions can be programmed. For Day Enter : 1 = Sunday, 2 = Monday, 3=Tuesday, 4 Wednesday 5 = Thursday, 6 = Friday, 7=Saturday, 8 = Monday - Friday 9 = Saturday and Sunday, 0=All days of the week Enter time of day in 24 hour format (00:00- 23:59)		
		:	
		:	
		:	
		:	
		:	
		:	
		:	
		:	
		:	
		:	
		:	
		:	
		:	
		:	
		:	
		:	
		:	
		:	
		:	
		:	
		:	
		:	
		:	
		:	
		:	
		:	
		:	
		:	

## ALARM LOCK LIMITED WARRANTY

ALARM LOCK SYSTEMS, INC. (ALARM LOCK) warrants its products to be free from manufacturing defects in materials and workmanship for twelve months following the date of manufacture. ALARM LOCK will, within said period, at its option, repair or replace any product failing to operate correctly without charge to the original purchaser or user.

This warranty shall not apply to any equipment, or any part thereof, which has been repaired by others, improperly installed, improperly used, abused, altered, damaged, subjected to acts of God, or on which any serial numbers have been altered, defaced or removed. Seller will not be responsible for any dismantling or reinstallation charges.

THERE ARE NO WARRANTIES, EXPRESS OR IMPLIED, WHICH EXTEND BEYOND THE DESCRIPTION ON THE FACE HEREOF. THERE IS NO EXPRESS OR IMPLIED WARRANTY OF MERCHANTABILITY OR A WARRANTY OF FITNESS FOR A PARTICULAR PURPOSE. ADDITIONALLY, THIS WARRANTY IS IN LIEU OF ALL OTHER OBLIGATIONS OR LIABILITIES ON THE PART OF ALARM LOCK.

Any action for breach of warranty, including but not limited to any implied warranty of merchantability, must be brought within the six months following the end of the warranty period. IN NO CASE SHALL ALARM LOCK BE LIABLE TO ANYONE FOR ANY CONSEQUENTIAL OR INCIDENTAL DAMAGES FOR BREACH OF THIS OR ANY OTHER WARRANTY, EXPRESS OR IMPLIED, EVEN IF THE LOSS OR DAMAGE IS CAUSED BY THE SELLER'S OWN NEGLIGENCE OR FAULT.

In case of defect, contact the security professional who installed and maintains your security system. In order to exercise the warranty, the product must be returned by the security professional, shipping costs prepaid and insured to ALARM LOCK. After repair or replacement, ALARM LOCK assumes the cost of returning products under warranty. ALARM LOCK shall have no obligation under this warranty, or otherwise, if the product has been repaired by others, improperly installed, improperly used, abused, altered, damaged, subjected to accident, nuisance, flood, fire or acts of God, or on which any serial numbers have been altered, defaced or removed. ALARM LOCK will not be responsible for any dismantling, reassembly or reinstallation charges.

This warranty contains the entire warranty. It is the sole warranty and any prior agreements or representations, whether oral or written, are either merged herein or are expressly cancelled. ALARM LOCK neither assumes, nor authorizes any other person purporting to act on its behalf to modify, to change, or to assume for it, any other warranty or liability concerning its products.

In no event shall ALARM LOCK be liable for an amount in excess of ALARM LOCK's original selling price of the product, for any loss or damage, whether direct, indirect, incidental, consequential, or otherwise arising out of any failure of the product. Seller's warranty, as hereinabove set forth, shall not be enlarged, diminished or affected by and no obligation or liability shall arise or grow out of Seller's rendering of technical advice or service in connection with Buyer's order of the goods furnished hereunder.

ALARM LOCK RECOMMENDS THAT THE ENTIRE SYSTEM BE COMPLETELY TESTED WEEKLY.

Warning: Despite frequent testing, and due to, but not limited to, any or all of the following; criminal tampering, electrical or communications disruption, it is possible for the system to fail to perform as expected. ALARM LOCK does not represent that the product/system may not be compromised or circumvented; or that the product or system will prevent any personal injury or property loss by burglary, robbery, fire or otherwise; nor that the product or system will in all cases provide adequate warning or protection. A properly installed and maintained alarm may only reduce risk of burglary, robbery, fire or otherwise but it is not insurance or a guarantee that these events will not occur. CONSEQUENTLY, SELLER SHALL HAVE NO LIABILITY FOR ANY PERSONAL INJURY, PROPERTY DAMAGE, OR OTHER LOSS BASED ON A CLAIM THE PRODUCT FAILED TO GIVE WARNING. Therefore, the installer should in turn advise the consumer to take any and all precautions for his or her safety including, but not limited to, fleeing the premises and allig police or fire department, in order to mitigate the possibilities of harm and/or damage.

ALARM LOCK is not an insurer of either the property or safety of the user's family or employees, and limits its liability for any loss or damage including incidental or consequential damages to ALARM LOCK's original selling price of the product regardless of the cause of such loss or damage.

Some states do not allow limitations on how long an implied warranty lasts or do not allow the exclusion or limitation of incidental or consequential damages, or differentiate in their treatment of limitations of liability for ordinary or gross